

TMD121C, TAMD121C, TAMD121D

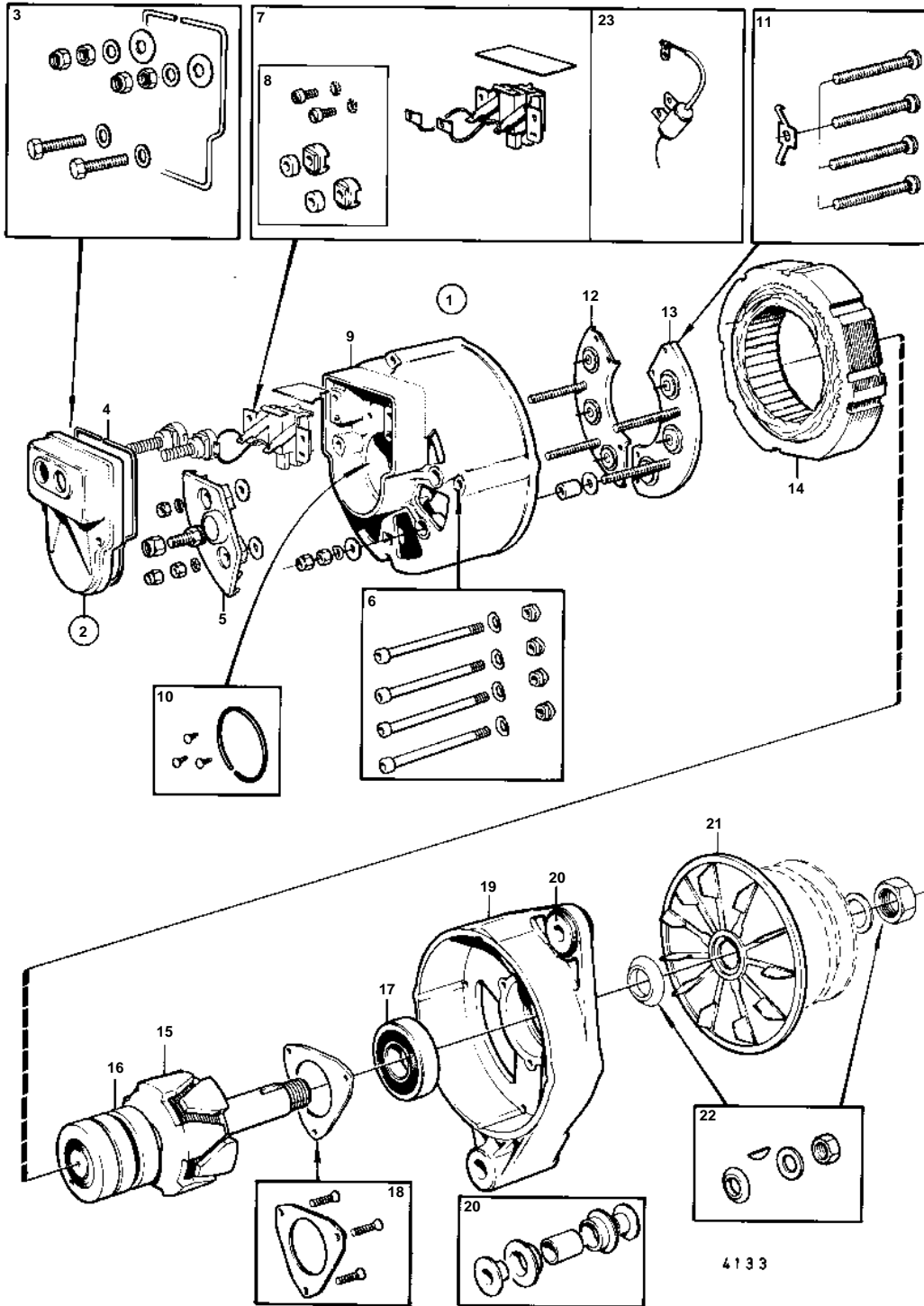

TMD121C, TAMD121C, TAMD121D

REF	PART NO.	QTY	DESCRIPTION	NOTES
1	827349	1	Alternator	28V 25A. For 24 voltage electric system
2		1	· Cover	
3	827560	1	· · Mounting kit	
4		1	· · · Gasket	
5	825532	1	· Diode retainer	
6		1	· Repair kit	
7	821723	1	· Carbon brush set	
8	827558	1	· Screw kit	
9		1	· Housing	
10		1	· Seal	
11		1	· Repair kit	
12	827563	1	· Diode retainer	
13	1517037	1	· Diode retainer	
14		1	· Stator	
15		1	· Rotor	
16		1	· · Bearing	
17	181875	1	· Ball bearing	
18	480655	1	· Repair kit	
19		1	· End cover	
20		1	· Guide	
21		1	· Fan	
22		1	· Mounting kit	
23	821725	1	· Capacitor	